

AXIS M5525-E PTZ Network Camera

User Manual

AXIS M5525-E PTZ Network Camera

Table of Contents

Product overview	3
How to connect a microphone to the camera	4
How to access the product	5
How to access the product from a browser	5
About secure passwords	5
Setup	7
About the product's built-in help	7
Image quality	7
Privacy masks	9
Overlays	9
PTZ (Pan Tilt Zoom)	10
Streaming and storage	10
Events	11
Applications	15
Troubleshooting	16
How to reset to factory default settings	16
Check the current firmware	16
Upgrade the firmware	16
Technical issues, clues and solutions	17
Performance considerations	18
Specifications	19
LED indicators	19
SD card slot	19
Buttons	19
Connectors	19

AXIS M5525-E PTZ Network Camera

Product overview

Product overview

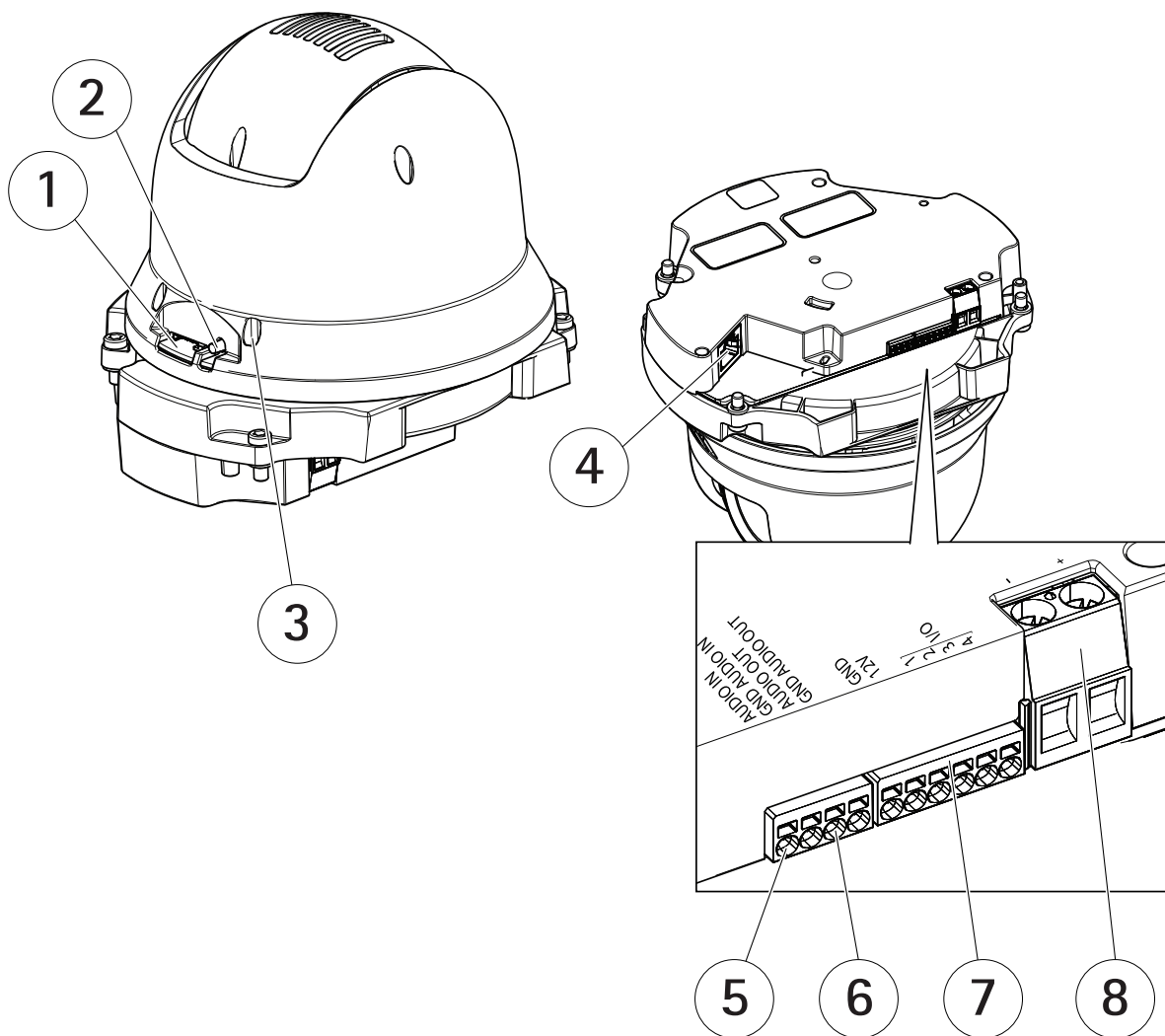

- 1 SD card slot (microSD)
- 2 Control button
- 3 Status LED
- 4 RJ45 connector
- 5 Audio in
- 6 Audio out
- 7 I/O connector
- 8 Power connector

AXIS M5525-E PTZ Network Camera

How to connect a microphone to the camera

How to connect a microphone to the camera

This example explains how to connect a microphone to the camera using an audio extension cable.

Required hardware

- AXIS T8351 Microphone 3.5 mm
- AXIS Audio Extension Cable A, 5 m (16 ft)

Note

- To avoid noise, don't run the cable close to or in parallel with other cables.
- To avoid noise, cut the cable as short as possible.
- To maintain IP66 rating, make sure you keep the jack inside the housing.

Connect the cables

1. Keep the 3.5 mm jack and cut the audio extension cable.
2. Strip the outer cable insulation.
3. Strip the inner wire insulation.
4. Twist the audio wires (with insulation) together.
5. Twist the grounding wires (without insulation) together.
6. Connect the audio wires to the AUDIO IN pin on the camera. See *Product overview on page 3*.
7. Connect the grounding wires to the GND AUDIO IN pin on the camera.
8. Connect the microphone to the jack of the audio extension cable.
9. Turn on audio and adjust other audio settings in the camera's webpage.

AXIS M5525-E PTZ Network Camera

How to access the product

How to access the product

AXIS IP Utility and AXIS Camera Management are recommended methods for finding Axis products on the network and assigning them IP addresses in Windows®. Both applications are free and can be downloaded from axis.com/support

The product can be used with the following browsers:

- Chrome™ (recommended), Firefox®, Edge®, or Opera® with Windows®
- Chrome™ (recommended) or Safari® with OS X®
- Chrome™ or Firefox® with other operating systems.

If you need more information about recommended browsers, go to axis.com/browser-support

How to access the product from a browser

1. Start a web browser.
2. Enter the IP address or host name of the Axis product in the browser's address field.

To access the product from a Mac computer (OS X), go to Safari, click on Bonjour and select the product from the drop-down list. To add Bonjour as a browser bookmark, go to **Safari > Preferences**.

If you do not know the IP address, use AXIS IP Utility to locate the product on the network. For information about how to discover and assign an IP address, see the document *Assign an IP Address and Access the Video Stream* on Axis Support web at axis.com/support

3. Enter your username and password. If this is the first time the product is accessed, the root password must first be configured.
4. The product's live view page opens in your browser.

About secure passwords

Important

Axis devices send the initially set password in clear text over the network. To protect your device after the first login, set up a secure and encrypted HTTPS connection and then change the password.

The device password is the primary protection for the data and services. Axis devices do not impose a password policy as they may be used in various types of installations. To protect your data we recommend that you:

- Change the default password that comes with the devices.
- Use a password with at least 8 characters, preferably created by a password generator.
- Don't expose the password.
- Change password at a recurring interval, at least once a year.

Set a secure password for the root account

Important

The default administrator user name **root** cannot be deleted. If the password for root is lost, the device must be reset to the factory default settings.

1. Make sure to follow the instructions about secure passwords. See *About secure passwords* on page 5.
2. Type a password and then retype it to confirm the spelling.

AXIS M5525-E PTZ Network Camera

How to access the product

3. Click **Create login**. The password has now been configured.

AXIS M5525-E PTZ Network Camera

Setup

Setup

About the product's built-in help

You can access the built-in help through your product's webpage. The help provides more detailed information on the product's features and their settings.

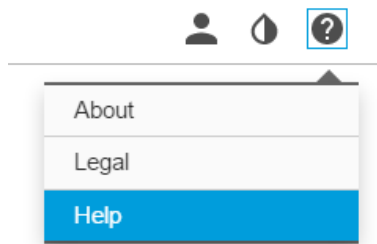

Image quality

How to select exposure mode

There are different exposure mode options in the camera that adjusts aperture, shutter speed, and gain to improve image quality for specific surveillance scenes. Go to **Settings > Image > Exposure** and select between the following exposure modes:

- For most use cases, select **Automatic** exposure.
- For environments with certain artificial lighting, for example fluorescent lighting, select **Flicker-free**.
Select the same frequency as the power line frequency.
- For environments with certain artificial light and bright light, for example outdoors with fluorescent lighting at night and sun during daytime, select **Flicker-reduced**.
Select the same frequency as the power line frequency.
- To lock the current exposure settings, select **Hold current**.

How to benefit from IR light in low-light conditions using night mode

Your camera uses visible light to deliver color images during the day. As light diminishes, you can set the camera to automatically shift to night mode. In night mode the camera uses both visible light and near-infrared light to deliver black-and-white images. Since the camera uses more of the available light it can deliver brighter, more detailed, images.

1. Go to **Settings > Image > Day and night**, and make sure that the **IR cut filter** is set to **Auto**.

How to handle scenes with strong backlight

To make both dark and bright areas of the image visible, turn on WDR.

1. Go to **Settings > Image**.
2. Turn on WDR under **Wide dynamic range**.

AXIS M5525-E PTZ Network Camera

Setup



Image without WDR.



Image with WDR.

Note

If you use WDR, you may experience some WDR artifacts in the image.

Find out more about WDR and how to use it at axis.com/web-articles/wdr

How to enhance facial recognition

To better recognize the face of a person passing by the camera, you can set the optimal pixel resolution with the camera's pixel counter.

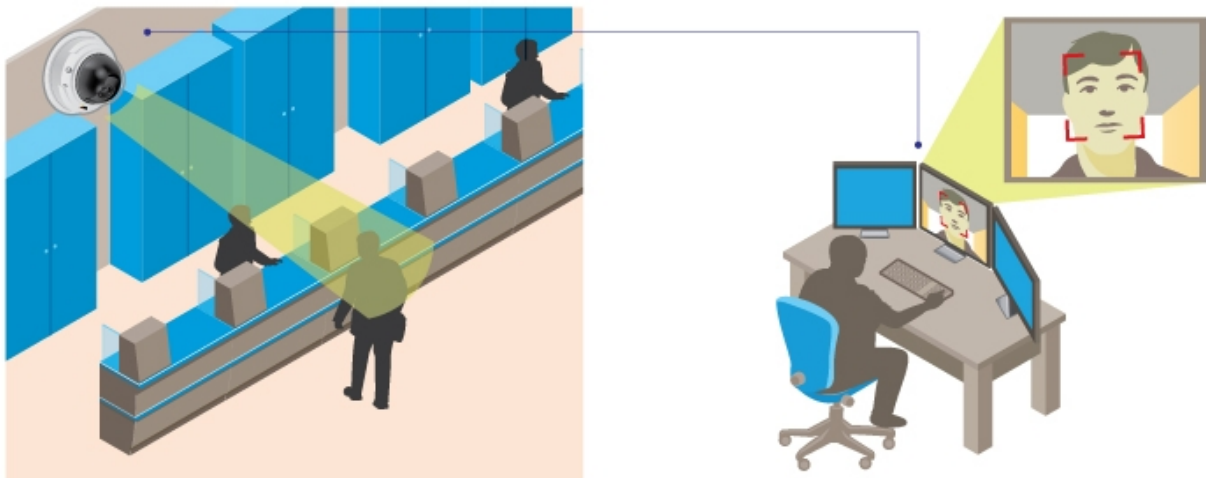

1. Go to Settings > System > Orientation and click .

AXIS M5525-E PTZ Network Camera

Setup

2. Adjust the size and placement of the rectangle in the camera's live view around the area of interest, for example where the faces of passing persons are expected to appear. You can then see the number of pixels represented by the sides of the rectangle.

Note

You can use an object of a known size in the view as a reference to decide how much resolution is needed for recognition.

Privacy masks

How to hide parts of the image with privacy masks

What is a privacy mask?

A privacy mask is a user-defined area that prevents users from viewing a part of the monitored area. In the video stream, privacy masks appear as blocks of solid color.

The privacy mask is relative to the pan, tilt, and zoom coordinates, so regardless of where you point the camera, the privacy mask covers the same place or object.

You'll see the privacy mask on all snapshots, recorded video, and live streams.

You can use the VAPIX® application programming interface (API) to turn off the privacy masks.

Important

Using multiple privacy masks may affect the product's performance.

How to create a privacy mask

To create a privacy mask, go to **Settings > Privacy mask**.

Overlays

About overlays

Overlays are superimposed over the video stream. They are used to provide extra information during recordings, such as a timestamp, or during product installation and configuration.

How to show a text overlay when the camera detects motion

This example explains how to display the text "Motion detected" when the camera detects motion:

Make sure the AXIS Video Motion Detection application is running:

1. Go to **Settings > Apps > AXIS Video Motion Detection**.
2. Start the application if it is not already running.
3. Make sure you have set up the application according to your needs.

Add the overlay text:

4. Go to **Settings > Overlay**.
5. Enter #D in the text field.
6. Choose alignment, text size and appearance.
7. **Include** the text overlay.

Create an action rule:

AXIS M5525-E PTZ Network Camera

Setup

8. Go to **System > Events > Action rules**.
9. Create an action rule with **AXIS Video Motion Detection** as trigger.
10. From the list of actions, select **Overlay text**.
11. Type "Motion detected".
12. Set the duration.

Note

If you update the overlay text it will be automatically updated on all video streams dynamically.

PTZ (Pan Tilt Zoom)

How to limit pan, tilt, and zoom movements

In this example, the camera is surveilling a parking lot with nearby apartment buildings. Set pan, tilt and zoom limits to ensure privacy for residents.

To limit pan, tilt and zoom movements, go to **Settings > PTZ > Limits**.

Streaming and storage

How to choose video compression format

Decide which compression method to use based on your viewing requirements, and on the properties of your network. The available options are:

Motion JPEG

Motion JPEG or MJPEG is a digital video sequence that is made up of a series of individual JPEG images. These images are then displayed and updated at a rate sufficient to create a stream that shows constantly updated motion. For the viewer to perceive motion video the rate must be at least 16 image frames per second. Full motion video is perceived at 30 (NTSC) or 25 (PAL) frames per second.

The Motion JPEG stream uses considerable amounts of bandwidth, but provides excellent image quality and access to every image contained in the stream.

H.264 or MPEG-4 Part 10/AVC

Note

H.264 is a licensed technology. The Axis product includes one H.264 viewing client license. Installing additional unlicensed copies of the client is prohibited. To purchase additional licenses, contact your Axis reseller.

H.264 can, without compromising image quality, reduce the size of a digital video file by more than 80% compared to the Motion JPEG format and by as much as 50% compared to the MPEG-4 standard. This means that less network bandwidth and storage space are required for a video file. Or seen another way, higher video quality can be achieved for a given bitrate.

How to reduce bandwidth and storage

Important

If you reduce the bandwidth it can result in loss of details in the picture.

1. Go to live view and select **H.264**.
2. Go to **Settings > Stream**.
3. Do one or more of the following:

AXIS M5525-E PTZ Network Camera

Setup

- Turn on the Zipstream functionality and select the desired level.
- Turn on dynamic GOP and set a high GOP length value.
- Increase the compression.
- Turn on dynamic FPS.

How to set up network storage

To store recordings on the network, you need to set up network storage:

1. Go to **Settings > System > Storage**.
2. Click **Setup** under **Network storage**.
3. Enter the IP address of the host server.
4. Enter the name of the shared location on the host server.
5. Move the switch if the share requires a login, and enter username and password.
6. Click **Connect**.

How to add audio to your recording

Edit the stream profile which is used for the recording:

1. Go to **Settings > System > Stream profiles**.
2. Select the stream profile and click **Modify**.
3. In the **Audio** tab, select the **Audio stream** checkbox and select **On** from the drop-down list.
4. Click **Ok**.

Events

About events

The event pages allow you to configure your product to perform actions when different events occur. For example, the product can start a recording or send an email notification when motion is detected. The set of conditions that defines how and when the action is triggered is called an action rule.

How to direct the camera to a preset position when the camera detects motion

This example explains how to set up the camera to go to a preset position when it detects motion in the image.

Make sure the AXIS Video Motion Detection application is running:

1. Go to **Settings > Apps > AXIS Video Motion Detection**.
2. Start the application if it is not already running.
3. Make sure you have set up the application according to your needs.

Add a preset position:

4. Go to **Settings > PTZ** and set where you want the camera to be directed by creating a preset position.

Create an action rule:

5. Go to **Settings > System > Events > Action rules** and add an action rule.

AXIS M5525-E PTZ Network Camera

Setup

6. Type a name for the action rule.
7. From the list of triggers, select **Applications** and then select **AXIS Video Motion Detection (VMD)**.
8. From the list of actions, select **PTZ Control** and then select **Preset Position**.
9. Select the preset position you want the camera to go to.
10. Click **Ok**.

How to record video when a PIR detector senses motion

This example explains how to connect an Axis PIR detector to the camera, and set up the camera to start recording when the detector senses motion.

Required hardware

- 3-wire cable (ground, power, I/O)
- Axis PIR detector

NOTICE

Disconnect the camera from power before connecting the wires. Reconnect to power after all connections are done.

Connect the wires to the camera's I/O connector

Note

For information on the I/O connector, see *Connectors on page 19*

1. Connect the ground wire to pin 1 (GND/-).
2. Connect the power wire to pin 2 (12V DC output).
3. Connect the I/O wire to pin 3 (I/O input).

Connect the wires to the PIR detector's I/O connector

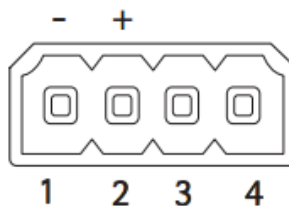

1. Connect the other end of the ground wire to pin 1 (GND/-).
2. Connect the other end of the power wire to pin 2 (DC input/+).
3. Connect the other end of the I/O wire to pin 3 (I/O output).

Configure the I/O port in the camera's web page

1. Go to **Settings > System > I/O ports**.
2. Select **Input** in the **Port 1** drop-down list.
3. Give the input module a descriptive name.
4. To make the PIR detector send a signal to the camera when it senses motion, select **Closed circuit** in the drop-down list.

AXIS M5525-E PTZ Network Camera

Setup

To trigger the camera to start recording when it receives a signal from the PIR detector, you need to create an action rule in the camera's web page.

Use audio to deter intruders

This example explains how to connect a speaker to the camera and set it up to play a warning message when the camera detects motion in a restricted area.

Required hardware

- Active speaker with built-in amplifier and connecting wires

NOTICE

Make sure the camera is disconnected from power before making the connections. Reconnect to power after connecting the wires.

Physical connection

1. Connect the audio wire from the speaker to the AUDIO OUT pin on the camera. See *Product overview on page 3*.
2. Connect the grounding wire from the speaker to the GND AUDIO OUT pin on the camera. See *Product overview on page 3*.

Add audio clip to the camera

1. Go to **Settings > Audio > Output** and click  to add your audio clip.
2. Click **Add**.
3. Select **Upload** under **Add Audio Clip Options**.
4. Browse to locate the audio clip and click **Upload**.

To trigger the camera to play the audio clip when it detects motion, create an action rule in the camera's webpage.

How to direct the camera and open the lock to a gate when someone is nearby

This example explains how to direct the camera and open a gate when someone wants to enter during daytime. This is done by connecting a PIR detector to the product's input port and a switch relay to the product's output port.

Required hardware

- Mounted PIR detector
- Switch relay connected to the gate lock, in this case the switch is normally closed (NC)
- Connecting wires

Physical connection

1. Connect the wires from the PIR detector to the input pin, see *I/O connector on page 20*.
2. Connect the wires from the switch to the output pin, see *I/O connector on page 20*.

Configure I/O ports

You need to connect the switch relay to the camera in the camera's webpage. First, configure the I/O ports:

Set the PIR detector to an input port

1. Go to **System > I/O ports**.

AXIS M5525-E PTZ Network Camera

Setup

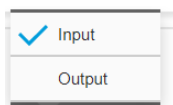

2. Select **Input** in the **Port 1** drop-down list.
3. Give the input module a descriptive name, for example "PIR detector".
4. To trigger an event whenever the PIR detector senses motion, select **Open circuit** in the drop-down

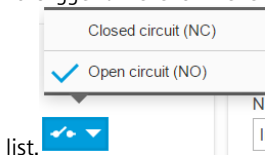

Set the switch relay to an output port

1. Go to **System > I/O ports**.

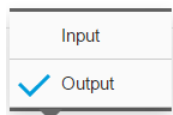

2. Select **Output** in the **Port 2** drop-down list.
3. Give the output module a descriptive name, for example "Gate switch".

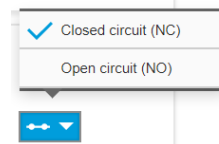

4. To open the gate whenever an event is triggered, select **Closed circuit** in the drop-down list.

Create action rules

For the camera to open the gate when the PIR detector senses someone nearby, you need to create an action rule in the camera:

1. Go to **System > Events > Action rules**.
2. Click **Add**.
3. Give the action rule a name, for example "Open gate".
4. From the **Trigger** drop-down list, select **Input signal**.
5. Select **Digital input signal**.
6. Select "PIR detector", in this example connected to port 1.
7. Under **Actions**, select **Output port** from the **Type** drop-down list.
8. From the **Port** drop-down list, select "Gate switch" .
9. Click **Ok**.
10. Create another action rule with the name "Direct the camera to the gate"
11. Select the same input signal as before, but as action select the previously created "Gate entrance" preset position.

AXIS M5525-E PTZ Network Camera

Setup

12. Click Ok.

Applications

About applications

AXIS Camera Application Platform (ACAP) is an open platform that enables third parties to develop analytics and other applications for Axis products. To find out more about available applications, downloads, trials and licenses, go to axis.com/applications

To find the user manuals for Axis applications, go to axis.com

Note

- Several applications can run at the same time but some applications might not be compatible with each other. Certain combinations of applications might require too much processing power or memory resources when run in parallel. Verify that the applications work together before deployment.

AXIS M5525-E PTZ Network Camera

Troubleshooting

Troubleshooting

How to reset to factory default settings

Important

Reset to factory default should be used with caution. A reset to factory default resets all settings, including the IP address, to the factory default values.

To reset the product to the factory default settings:

1. Disconnect power from the product.
2. Press and hold the control button while reconnecting power. See *Product overview on page 3*.
3. Keep the control button pressed for 15–30 seconds until the status LED indicator flashes amber.
4. Release the control button. The process is complete when the status LED indicator turns green. The product has been reset to the factory default settings. If no DHCP server is available on the network, the default IP address is 192.168.0.90
5. Use the installation and management software tools to assign an IP address, set the password, and access the video stream.

The installation and management software tools are available from the support pages on axis.com/support

It is also possible to reset parameters to factory default via the web interface. Go to **Settings > System > Maintenance** and click **Default**.

Check the current firmware

Firmware is the software that determines the functionality of network devices. One of your first actions when troubleshooting a problem should be to check the current firmware version. The latest version may contain a correction that fixes your particular problem.

To check the current firmware:

1. Go to the product's webpage.
2. Click on the help menu .
3. Click **About**.

Upgrade the firmware

Important

Preconfigured and customized settings are saved when the firmware is upgraded (provided that the features are available in the new firmware) although this is not guaranteed by Axis Communications AB.

Important

Make sure the product remains connected to the power source throughout the upgrade process.

Note

When you upgrade the product with the latest firmware in the active track, the product receives the latest functionality available. Always read the upgrade instructions and release notes available with each new release before upgrading the firmware. To find the latest firmware and the release notes, go to axis.com/support/firmware.

1. Download the firmware file to your computer, available free of charge at axis.com/support/firmware.

AXIS M5525-E PTZ Network Camera

Troubleshooting

2. Log in to the product as an administrator.
3. Go to **Settings > System > Maintenance**. Follow the instructions on the page. When the upgrade has finished, the product restarts automatically.

AXIS Device Manager can be used for multiple upgrades. Find out more at axis.com/products/axis-device-manager.

Technical issues, clues and solutions

If you can't find what you're looking for here, try the troubleshooting section at axis.com/support

Problems upgrading the firmware

Firmware upgrade failure	If the firmware upgrade fails, the product reloads the previous firmware. The most common reason is that the wrong firmware file has been uploaded. Check that the name of the firmware file corresponds to your product and try again.
--------------------------	---

Problems setting the IP address

The product is located on a different subnet	If the IP address intended for the product and the IP address of the computer used to access the product are located on different subnets, you cannot set the IP address. Contact your network administrator to obtain an IP address.
--	---

The IP address is being used by another device	Disconnect the Axis product from the network. Run the ping command (in a Command/DOS window, type <code>ping</code> and the IP address of the product): <ul style="list-style-type: none">• If you receive: <code>Reply from <IP address>: bytes=32; time=10...</code> this means that the IP address may already be in use by another device on the network. Obtain a new IP address from the network administrator and reinstall the product.• If you receive: <code>Request timed out</code>, this means that the IP address is available for use with the Axis product. Check all cabling and reinstall the product.
--	---

Possible IP address conflict with another device on the same subnet	The static IP address in the Axis product is used before the DHCP server sets a dynamic address. This means that if the same default static IP address is also used by another device, there may be problems accessing the product.
---	---

The product cannot be accessed from a browser

Cannot log in	When HTTPS is enabled, ensure that the correct protocol (HTTP or HTTPS) is used when attempting to log in. You may need to manually type <code>http</code> or <code>https</code> in the browser's address field.
---------------	--

If the password for the user `root` is lost, the product must be reset to the factory default settings. See *How to reset to factory default settings on page 16*.

The IP address has been changed by DHCP	IP addresses obtained from a DHCP server are dynamic and may change. If the IP address has been changed, use AXIS IP Utility or AXIS Camera Management to locate the product on the network. Identify the product using its model or serial number, or by the DNS name (if the name has been configured).
---	---

If required, a static IP address can be assigned manually. For instructions, go to axis.com/support

Certificate error when using IEEE 802.1X	For authentication to work properly, the date and time settings in the Axis product must be synchronized with an NTP server. Go to Settings > System > Date and time
--	---

The product is accessible locally but not externally

Router configuration	Check that your router allows incoming data traffic to the Axis product. The router must support UPnP®.
----------------------	---

Firewall protection	Check the Internet firewall with your network administrator.
---------------------	--

AXIS M5525-E PTZ Network Camera

Troubleshooting

Problems with streaming

Multicast H.264 only accessible by local clients	Check if your router supports multicasting, or if the router settings between the client and the product need to be configured. The TTL (Time To Live) value may need to be increased.
No multicast H.264 displayed in the client	Check with your network administrator that the multicast addresses used by the Axis product are valid for your network. Check with your network administrator to see if there is a firewall preventing viewing.
Poor rendering of H.264 images	Ensure that your graphics card is using the latest driver. The latest drivers can usually be downloaded from the manufacturer's website.
Color saturation is different in H.264 and Motion JPEG	Modify the settings for your graphics adapter. Go to the adapter's documentation for more information.
Lower frame rate than expected	<ul style="list-style-type: none">• See <i>Performance considerations on page 18</i>.• Reduce the number of applications running on the client computer.• Limit the number of simultaneous viewers.• Check with the network administrator that there is enough bandwidth available.• Lower the image resolution.• In the product's webpage, set a capture mode that prioritizes frame rate. Changing the capture mode to prioritize frame rate might lower the maximum resolution depending on the product used and capture modes available.

Performance considerations

When setting up your system, it is important to consider how various settings and situations affect the performance. Some factors affect the amount of bandwidth (the bitrate) required, others can affect the frame rate, and some affect both. If the load on the CPU reaches its maximum, this also affects the frame rate.

The following factors are the most important to consider:

- High image resolution or lower compression levels result in images containing more data which in turn affects the bandwidth.
- Access by large numbers of Motion JPEG or unicast H.264 clients affects the bandwidth.
- Simultaneous viewing of different streams (resolution, compression) by different clients affects both frame rate and bandwidth.

Use identical streams wherever possible to maintain a high frame rate. Stream profiles can be used to ensure that streams are identical.

- Accessing Motion JPEG and H.264 video streams simultaneously affects both frame rate and bandwidth.
- Heavy usage of event settings affects the product's CPU load which in turn affects the frame rate.
- Using HTTPS may reduce frame rate, in particular if streaming Motion JPEG.
- Heavy network utilization due to poor infrastructure affects the bandwidth.
- Viewing on poorly performing client computers lowers perceived performance and affects frame rate.
- Running multiple AXIS Camera Application Platform (ACAP) applications simultaneously may affect the frame rate and the general performance.

AXIS M5525-E PTZ Network Camera

Specifications

Specifications

To find the latest version of the product's datasheet, go to the product page on axis.com and locate **Support & Documentation**.

LED indicators

Status LED	Indication
Unlit	Connection and normal operation.
Green	Shows steady green for 10 seconds for normal operation after startup completed.
Amber	Steady during startup. Flashes during firmware upgrade or reset to factory default.
Amber/Red	Flashes amber/red if network connection is unavailable or lost.

SD card slot

NOTICE

- Risk of damage to SD card. Do not use sharp tools, metal objects, or excessive force when inserting or removing the SD card. Use your fingers to insert and remove the card.
- Risk of data loss and corrupted recordings. Do not remove the SD card while the product is running. Unmount the SD card from the product's webpage before removal.

This product supports microSD/microSDHC/microSDXC cards.

For SD card recommendations, see axis.com

Buttons

Control button

The control button is used for:

- Resetting the product to factory default settings. See *How to reset to factory default settings on page 16*.
- Connecting to an AXIS Video Hosting System service. To connect, press and hold the button for about 3 seconds until the status LED flashes green.

Connectors

Network connector

RJ45 Ethernet connector with Power over Ethernet (PoE).

Audio connector

4-pin terminal block for audio input and output. See *Product overview on page 3*.

For audio in, the left channel is used from a stereo signal.

Pin	Notes
AUDIO IN	Microphone or line in (mono)

AXIS M5525-E PTZ Network Camera

Specifications

GND AUDIO IN	Ground audio in
AUDIO OUT	Line audio out
GND AUDIO OUT	Ground audio out

I/O connector

Use the I/O connector with external devices in combination with, for example, motion detection, event triggering, and alarm notifications. In addition to the 0 V DC reference point and power (DC output), the I/O connector provides the interface to:

Digital input – For connecting devices that can toggle between an open and closed circuit, for example PIR sensors, door/window contacts, and glass break detectors.

Digital output – For connecting external devices such as relays and LEDs. Connected devices can be activated by the VAPIX® Application Programming Interface or in the product's webpage.

6-pin terminal block. See *Product overview on page 3*.

Function	Pin	Notes	Specifications
0 V DC (-)	GND	DC ground	0 V DC
DC output	12 V	Can be used to power auxiliary equipment. Note: This pin can only be used as power out.	12 V DC Max load = 50 mA
Configurable (Input or Output)	I/O 1-4	Digital input – Connect to pin GND to activate, or leave floating (unconnected) to deactivate.	0 to max 30 V DC
		Digital output – Internally connected to pin 1 (DC ground) when active, and floating (unconnected) when inactive. If used with an inductive load, e.g. a relay, a diode must be connected in parallel with the load, for protection against voltage transients.	0 to max 30 V DC, open drain, 100 mA

Power connector

2-pin terminal block for DC power input. Use a Safety Extra Low Voltage (SELV) compliant limited power source (LPS) with either a rated output power limited to ≤ 100 W or a rated output current limited to ≤ 5 A.

