



# Plate Brackets (MISUMI)



Part Number **HFBL5-2020-384**

20220515224546

<b>Material</b>	A6N01SS-T5 Aluminum Alloy	<b>Surface Finish</b>	Clear Anodize
<b>Extrusion Series</b>	HFS	<b>Extrusion No.</b>	5
<b>Extrusion Size</b>	For 2020	<b>Bracket Type</b>	Brackets for Reinforcement
<b>Applicable Screws</b>	M5 Screws	<b>Number of Extrusion Connection Holes</b>	2
<b>Overall Length L(mm)</b>	384	-	-

(No surface treatment on 45° cut ends and counterbores.)

**HFBL5-2020**  
**HFBL5-2040**

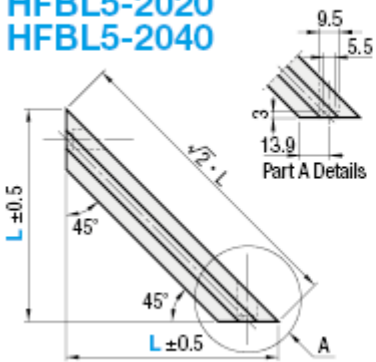

**HFBL5-4020**

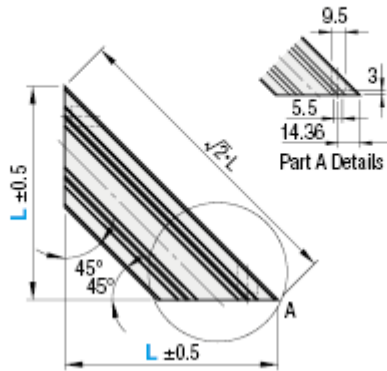

<Front View>  
HFBL5-2020  
HFBL5-4020



<Front View>  
HFBL5-2040

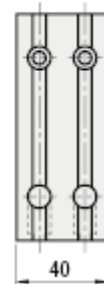

Alterations	Code	Spec.	Applicable Bracket
Set of Applicable Screws and Nuts	SET SST (Stainless Steel)	Applicable screws and nuts for fixing the brackets on extrusions come in a set. (Adds to the bracket price)  (Ex.) When HFBL5 is specified	HFBL5-2020
	SEU (Pre-Assembly Insertion Spring Nuts)		
	SSU (Pre-Assembly Insertion Spring Nuts Stainless Steel)		HFBL5-2040
	SEP (Post-Assembly Insertion Spring Nuts)		
	SSP (Post-Assembly Insertion Spring Nuts Stainless Steel)		HFBL5-4020

⚠ Not RoHS compliant when -SET, -SEU and -SEP are specified.